

**PB8HDX
PB16HDX
PB24HDX**

High Density HDX™ I/O Racks

For Single & DUAL I/O Modules

Compatibility

DUAL Types

- Gx2™-Series (DUAL)

Single Types

- G-Series
- G4 Types
- 70G Types
- G-5 Types
- C4 Types

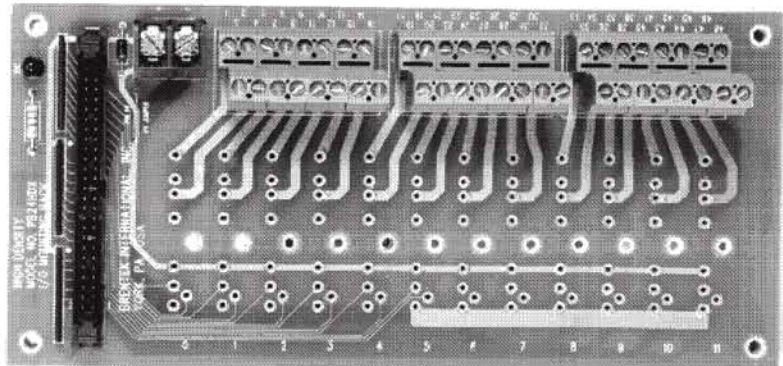

PB24HDX Shown

Dimensions

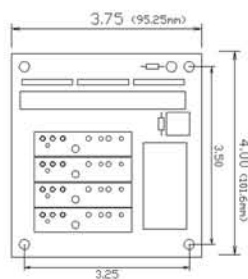

PB8HDX

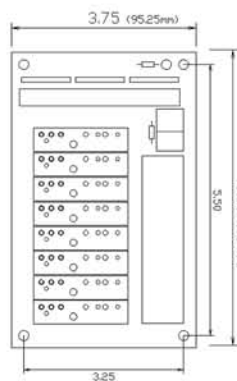

PB16HDX

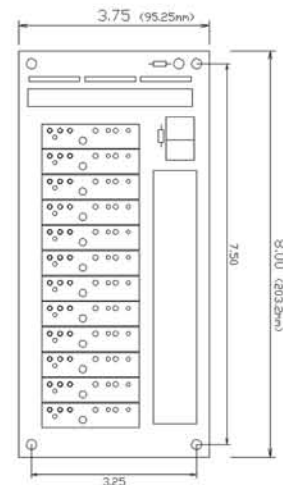

PB24HDX

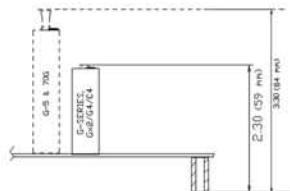

Dimensions are in inches except where noted otherwise.

Description

The High Density HDX™ I/O Mounting Racks accept both DUAL Gx2™-Series and single G-Series, G4, G5, 70G and C4 I/O modules. Terminals are provided for field wiring ranging from #22 to #12 AWG rated at 300V, 15A. A standard 50 pin IDC connector is provided for the control logic interface (see schematic diagrams). Each position provides a #4-40 insert for module hold-down screw.

Very high I/O point density is achieved when using Brentek's Gx2™-Series DUAL I/O Modules providing 24 I/O points in 30 square inches (a 16 sq. in. panel space reduction over single point designs). Single Form C Modules are also available (see Gx2™-Series in this catalog).

High Density HDX™ I/O Racks

**PB8HDX
PB16HDX
PB24HDX**

For Single & DUAL I/O Modules

Schematic Diagrams

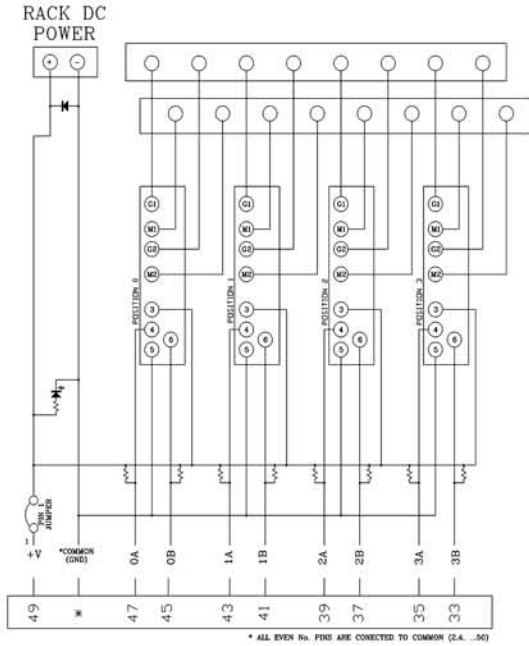

50 PIN INTERFACE CONNECTOR

PB8HDX

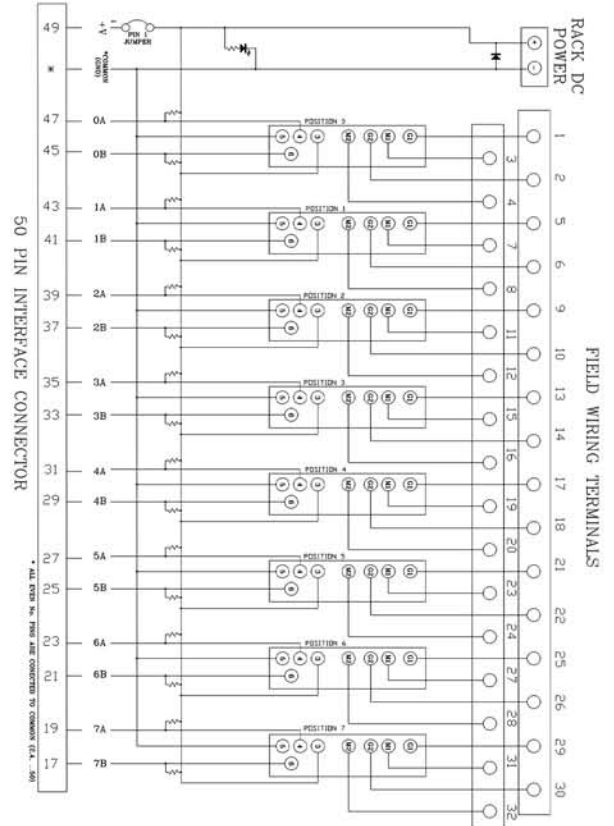

PB16HDX

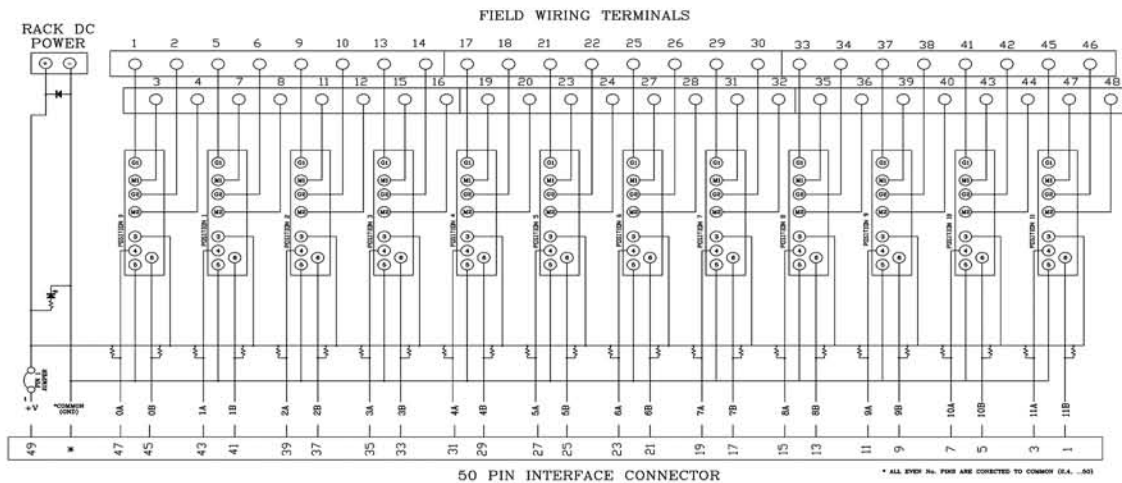

PB24HDX

NOTE: * ALL EVEN NUMBERED PINS ARE CONNECTED TO COMMON (2, 4, ...50)